

Turn your grey into

Green



Greywater diversion device

With washable and replaceable filters



Cross-flow depth filtration and multi-chamber plug flow concept

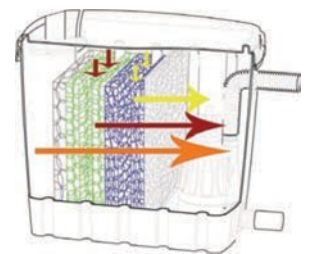

HOW IT WORKS:

Step 1. When the valve is open, greywater flows directly to the mains sewage or septic tank

Step 2. When the valve is closed, greywater from the house is diverted to the inlet of the filter

Step 3. The greywater flows through the 1st filter web that retains major and medium particles such as hair, lint, paper detergent clogs and other impurities (The filter web: Matala Black - Low density, Matala Green - Medium density)

Step 4. The greywater flows through the 2nd filter web that retains medium and small particles (The filter web: Matala Green - Medium density, Matala Blue - High density)

Step 5. The greywater flows through the 3rd filter web that retains small and minor particles (The filter web: Matala Blue - High density, Matala Gray Super high density)

Step 6. Filtered greywater is pumped to the irrigation.

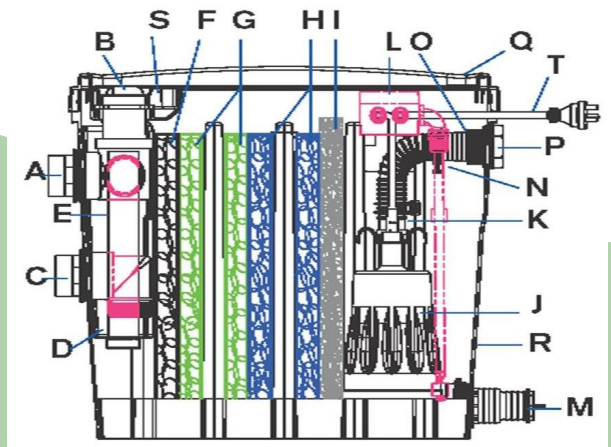

- a. Inlet (2")
- b. Diverting valve
- c. Outlet to sewer (2")
- d. Basket
- e. Overflow stand pipe
- f. Matala FSM190 Black
- g. Matala FSM290 Green
- h. Matala FSM365 Blue
- i. Matala FSM460 Grey
- j. Water pump
- k. Pump outlet
- l. Electronic pump controller
- m. Drain/Cleanout point with 1" plug
- n. Kink-free hose and hose clamp
- o. Outlet Connector
- p. Outlet
- q. Tank Cover
- r. Tank
- s. Inlet cover
- t. Electrical pump lead

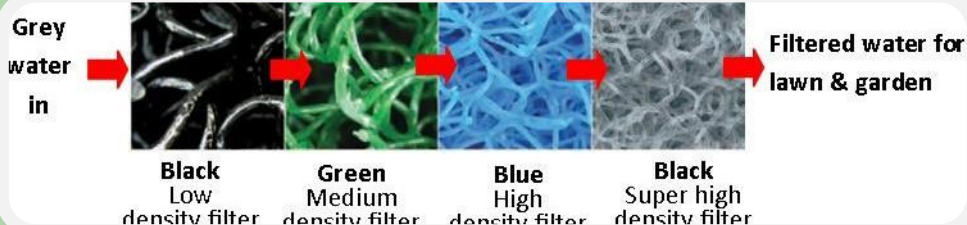

Features & Benefits

- 30 litres (6.8 gallons) of Matala filter media provides 10m² (108ft²) of specific surface area and 90% void space
- Cross-Flow depth filtration: each filter web has a 3-dimensional structure, able to trap a high volume of impurities without plugging
- Multi-chamber plug flow concept: If the first filter web gets clogged the filtration is done by the 2nd and 3rd filter web. If the 2nd web gets clogged, the filtration is done by the 3rd filter web
- Solid removal: up to 75% for pump operated unit, 90% for gravity unit
- Submersible pump with integrated Electronic Pump Controller (EPC)
- The pump is protected from dry run, clogging and damage with built in overflow safety
- Easy to clean
- System can be installed above ground, half-submerged in ground, or underground

Aqua2use dimensions

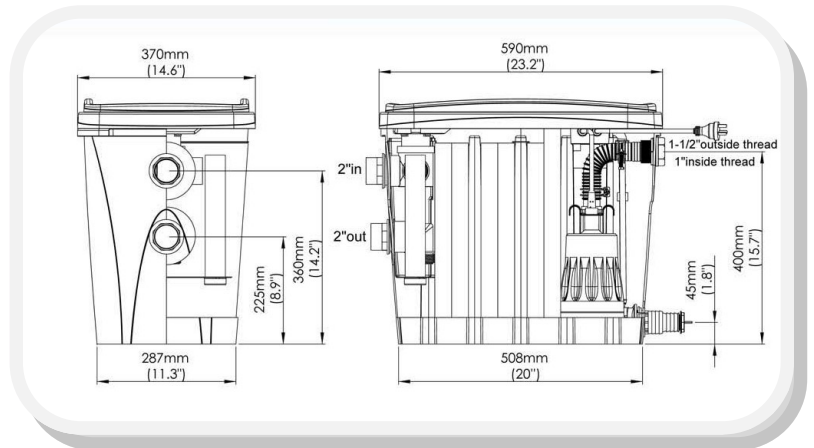

Pump Specifications

Output			Rated		Maximum		Dimension	Weight
HP	W	mm	Head (m)	Flow (l/m)	Head (m)	Flow (l/m)	LxWxH (mm)	Kg
1/4	200	25-32	5	53	7	136	155x155x240	4.2

How much water can we reuse?

Use	Residential Water Usage (Single Household) Litres/person/day	Reuse
Showers	90	<input checked="" type="checkbox"/>
Washing Machine	22	<input checked="" type="checkbox"/>
Toilet	38	<input type="checkbox"/>
Washbasins/ Kitchen	30	<input type="checkbox"/>
TOTAL	180	

Shower waste	90%
Washing machine	22 litres
Potential water reuse	112 litres/person/day 40,880 litres/person/year

Pump performance curve

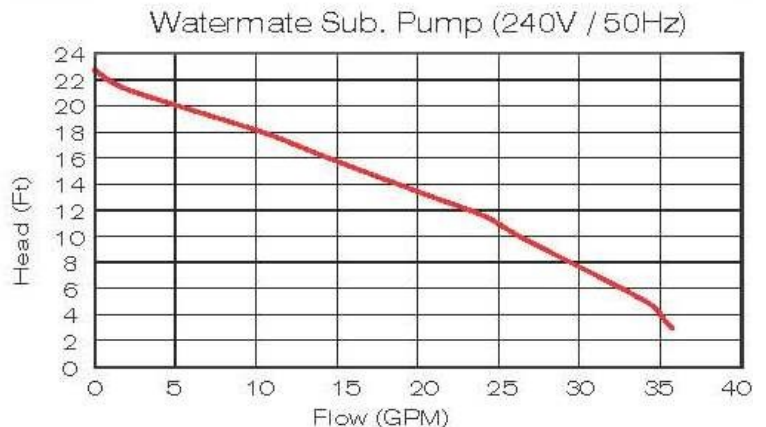

Unit tested in a caravan park, Australia

Matala greywater diverter checked after filtering 40,000 litres incoming greywater: public shower rooms and laundry

Proportion of in-house usage available for re-use

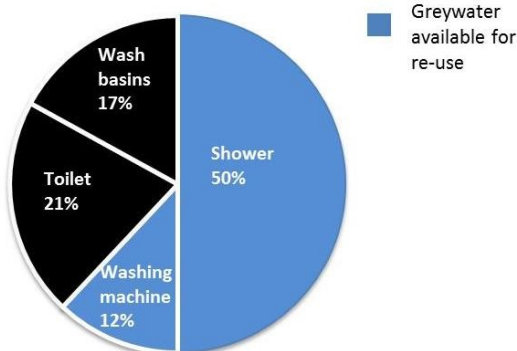

Data source: On-site NewZ Table A4

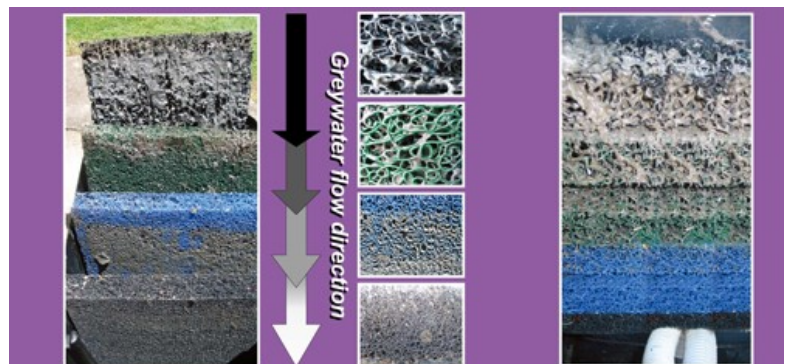

These pictures prove the high filtration efficiency achieved with progressive density Matala filter sheets. The filter can take up a huge volume of hair, lint, sand, soap, residues etc.